



LAZY L RIGHT ORDER FORM

ORDER QUOTE

NEW INSTALLATION REPLACEMENT JOB NAME: _____

SHIPPING INSTRUCTIONS
BRANCH DEALER
 COMMON CARRIER
OTHER _____

BRANCH _____
P.O. # _____
SHIPPING ADDRESS BRANCH DEALER
NAME _____
STREET _____
CITY/STATE _____
PHONE # _____ ZIP _____
BRANCH E-MAIL _____

DATE _____ DEALER P.O.# _____
DEALER NAME _____
STREET _____
CITY/STATE _____
PHONE # _____ ZIP _____
DEALER FAX # _____
MARK BOX HOMEOWNER _____
DEALER E-MAIL _____

I authorize Latham Pool Products to enter the alternate material selections when the primary selection is not available.
 CHECK BOX & INIT.

PRIMARY MATERIAL SELECTION (PRINT)
20 MIL
27 MIL VINYL TILE/ WALL PATTERN (FULL NAME)
20 MIL
27 MIL FLOOR PATTERN

ALTERNATE MATERIAL SELECTION - #1 (PRINT)
20 MIL
27 MIL VINYL TILE/ WALL PATTERN (FULL NAME)
20 MIL
27 MIL FLOOR PATTERN

ALTERNATE MATERIAL SELECTION - #2 (PRINT)
20 MIL
27 MIL VINYL TILE/ WALL PATTERN (FULL NAME)
20 MIL
27 MIL FLOOR PATTERN

BEAD TYPE: BEADED
 STD. INGROUND - UNIVERSAL OTHER: SEE BEAD CHART _____

OVERLAP (OVERLAP INCHES) _____

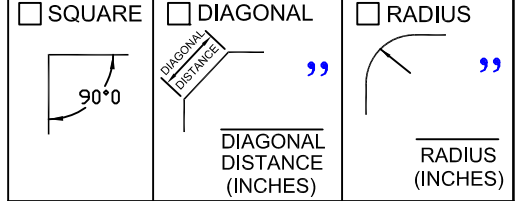
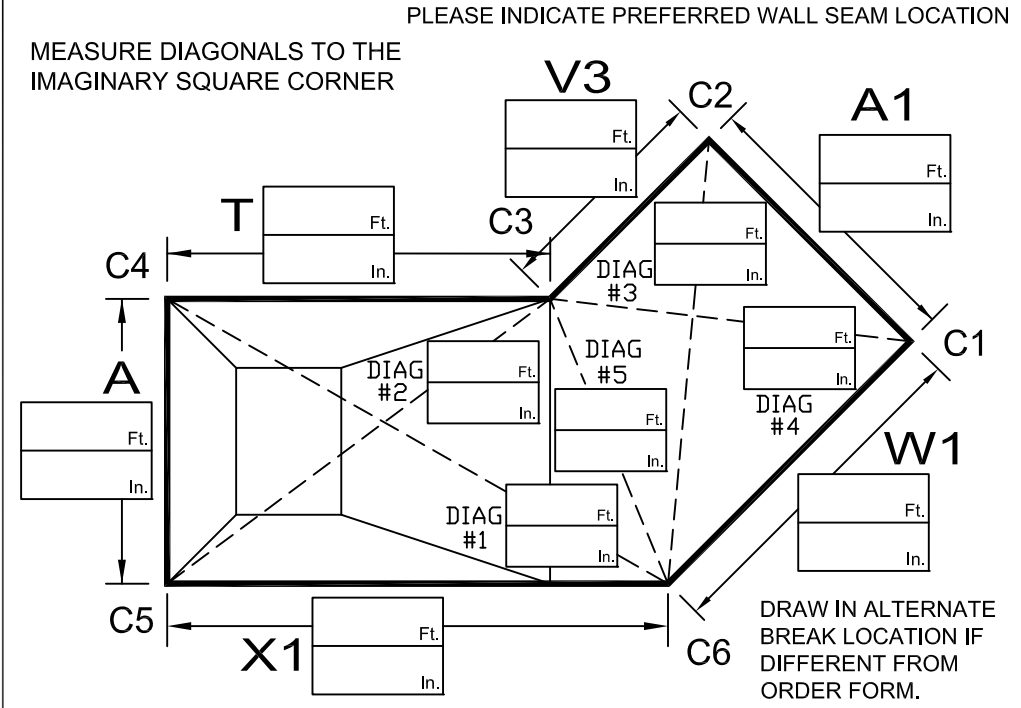

DEEP END SAFETY LEDGE: (S/S1/RD)
SIZE OF LEDGE = _____
INCLUDE DETAIL IF LEDGE IS NOT UNIFORM

VINYL COVERED STEPS:
IF YES: SHOW LOCATION ON TOP VIEW & INCLUDE STEP PAGE.
CENTER OF SHALLOW END
STEPS ARE LOCATED BETWEEN
'C' Point _____ & 'C' Point _____
" From 'C' " From 'C' "

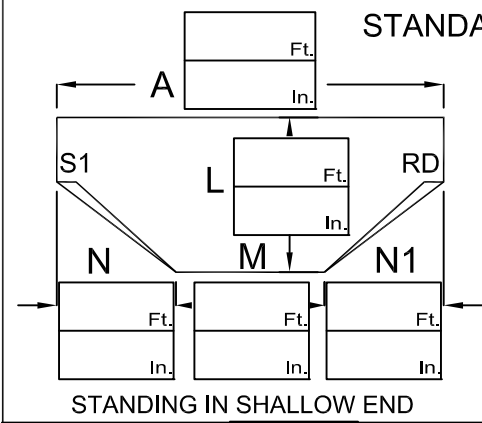

STANDARD HOPPER BOTTOM

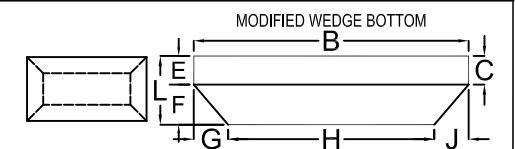
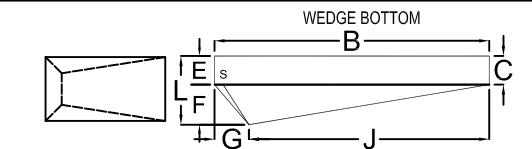
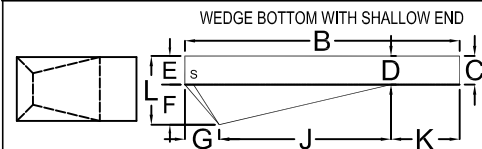
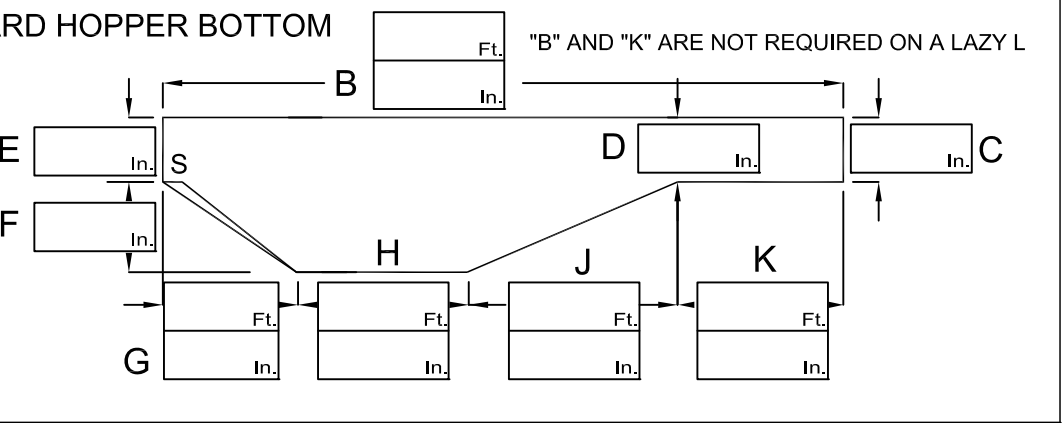

PRE SUBMISSION CHECK LIST

latham

Avoid additional trips to your job site. Check the dimensions and information below. Incorrect, missing or illegible dimensions may delay production and delivery.

LINERS

- ✓ **Vinyl Over Steps**
 - Fastener Type: Bead, Velcro, Rod Pockets, None.
 - Coping: Front or Top Mount.
 - Corners: Square, Diagonal or Radius.
 - Location: Indicate step's location.
- ✓ **A/B Points & Distances**
 - A/B Points – Indicate distance between A/B Points.
 - Sketch – Pool Shape, A/B line, hopper & pool direction.
- ✓ **Overall Dimensions**

New Pools – Provide manufacturer's panel layout, or see existing pools below.

Existing Pools – Please complete the Latham Order Form. Individual pool bottom measurements MUST = overall length and width (A&B) measurements.
- ✓ **Grecian Pools**

Provide dimensions for all sides of the pool & hopper pad shape. Measure to the point of the pool corner, not a radius coping.
- ✓ **Pool Corners**

Indicate Square, Diagonal or Radius. Indicate dimensions in inches. Guides are available to help determine sizes.
- ✓ **Color / Pattern / Thickness**

Clearly indicate these three choices.
- ✓ **ABG Liners**

Indicate: A) Wall height, B) Bead or Overlap, C) Make if non-standard.
- ✓ **Preformed Steps**

Indicate step location within pool perimeter for liner wall seam location.

SAFETY COVERS

- ✓ **Step Dimensions**

Double check Depth, Width, & Shape.
- ✓ **A/B Points & Distances**

Free Form Covers – include:

 - Distance between A/B points.
 - Pool sketch showing A/B line, pool direction, and all obstructions.
 - Replacement covers – measure to anchors and pool from the same A/B line.
- ✓ **Corners**

Indicate pool corners as Square, Diagonal or Radius. Include dimensions in inches. Guides are available to help determine sizes.
- ✓ **Grid Spacing**

Geometric shapes must indicate 3x3 or 5x5.
- ✓ **Grecian Covers**

Provide dimensions for all sides of the pool. Measure to the point of the pool corner, not a radius coping.
- ✓ **Color / Material**

Clearly indicate these choices.
- ✓ **Pump / Drain / Waiver**

One must be selected.
- ✓ **Deck Type & Size**
 - Confirm at least 3' of deck; decks less than 3' can use the reduced deck mount system.
 - Indicate Deck type, Anchor, and if padding is required.
- ✓ **Obstructions**
 - Indicate all non-removable obstructions within 3' of the pool.
 - Provide photos of all obstructions.