



BRAND: _____ *ORDER* *QUOTE*

BRANCH _____

DATE _____ DEALER P.O.# _____

P.O. # _____

DEALER NAME _____

SHIPPING ADDRESS BRANCH DEALER

STREET _____

NAME _____

CITY/STATE _____

STREET _____

PHONE # _____ ZIP _____

CITY/STATE _____

DEALER FAX # _____

PHONE # _____ ZIP _____

MARK BOX HOMEOWNER _____

BRANCH E-MAIL _____

DEALER E-MAIL _____

SHIPPING INSTRUCTIONS

BRANCH DEALER

COMMON CARRIER

VIA _____

AIR FREIGHT _____ DAY

OTHER _____

SQUARE

DIAGONAL

RADIUS

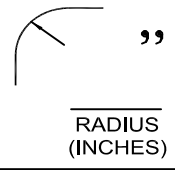
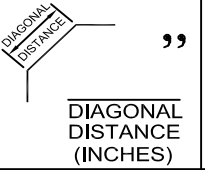
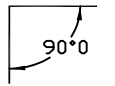

5x5 SPACING

3x3 SPACING

5000M STD. SHADE MESH

GREEN BLUE

TAN GRAY

7000MS HIGH SHADE MESH

GREEN BLUE

TAN GRAY

9000MX MAX SHADE MESH

BLACK & TAN STRIPED

500P LITE DUTY SOLID

GREEN BLUE

1000V HEAVY DUTY SOLID

GREEN BLUE

TAN GRAY

SOLID COVER DRAINAGE

WITH PUMP

WITH INVIS-A-DRAIN

CENTER MESH DRAIN

NO DRAIN - NO PUMP (SIGNED RELEASE REQUIRED)

POOL CORNER TYPE * CORNERS UP TO & INCLUDING 2' RADIUS OR 2' DIAGONAL ARE MADE 90° UNLESS OTHERWISE SPECIFIED, OVER 2' RADIUS OR 2' DIAGONAL ARE CUT CORNERS

STEPS ARE LOCATED BETWEEN (PLEASE USE INCHES FOR C-POINT DISTANCE)

STEP 1

'C' Point _____ & 'C' Point _____ " From 'C' _____

_____ " From 'C' _____

STEP 2

'C' Point _____ & 'C' Point _____ " From 'C' _____

_____ " From 'C' _____

ROMAN END

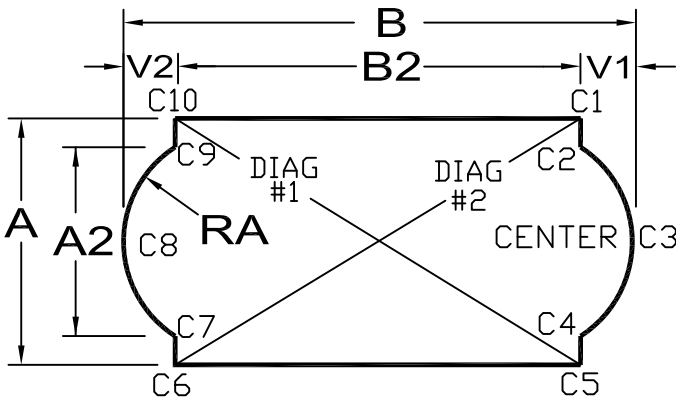

MOLDED RADIUS

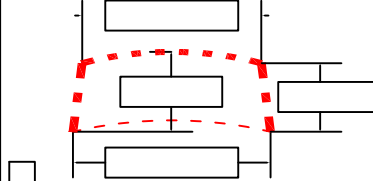

MOLDED STRAIGHT

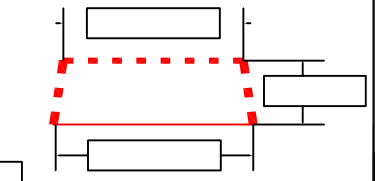

RECTANGLE STEP

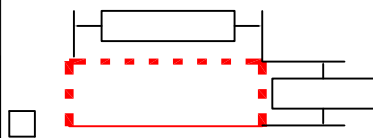

ROMAN STEP

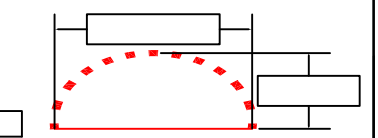

IF YOUR POOL HAS OBSTRUCTIONS WITHIN 3'-0" OF THE POOL; PLEASE PROVIDE DETAILS ON OUR CUSTOM ORDER FORMS (SC- 01, 02, 03, 04, 05, 06).

ALL CONCRETE DECK: ALL WOOD DECK: ALL PAVER DECK:

OTHER DECK? _____

IS THE COPING / DECK ROUGH? YES NO

DO YOU WANT SEWN ON PERIMETER PADDING? YES NO

IS THERE LESS THAN 3' OF DECK AROUND POOL PERIMETER ? YES NO

IF DECK IS LESS THAN 3'-0" PLEASE PROVIDE A SKETCH WITH LOCATIONS AND THE AMOUNT OF DECK AT EACH LOCATION.

RDM'S (REDUCED DECK MOUNT): THIS OPTION MOVES THE SPRING ON TOP OF THE SAFETY COVER. FOR 12" OVERLAP SAFETY COVERS 20" OF DECK IS REQUIRED. FOR 18" OVERLAP SAFETY COVERS 24" OF DECK IS REQUIRED. RDM'S? YES NO (UPCHARGES PER RDM APPLY)

IS DECK CONTOURED ? (FOLLOWS PERIMETER OF POOL) YES NO ADDITIONAL DETAILS MAY BE REQUIRED. PLEASE PROVIDE A SKETCH

ADDITIONAL HARDWARE: (UPCHARGE REQUIRED)

Y-STRAP: (FOR DIVING BOARD STANDS 18 TO 30 INCHES FROM THE POOL)

WOOD DECK ANCHORS: LENGTH OF DECK WITH WOOD DECK? _____

BRASS ANCHOR COLLARS: LENGTH OF DECK WITH COLLARS? _____

LAWN TUBES: LENGTH OF PLANTING BED OR GRASS AREAS? _____ NOTE: LAWN TUBES ARE USED FOR PAVER DECK APPLICATIONS

SKETCH IN STEP LOCATION

POOL DIMENSIONS

| | FEET | INCHES | | FEET | INCHES |
|----|------|--------|----|------|--------|
| A | | | A2 | | |
| B | | | B2 | | |
| V1 | | | V2 | | |
| | | | RA | | |

DIAGONALS SHOULD BE TAKEN FROM A 90 DEGREE CORNER.

| | | | | | |
|---------|--|--|---------|--|--|
| DIAG #1 | | | DIAG #2 | | |
|---------|--|--|---------|--|--|

PRE SUBMISSION CHECK LIST



Avoid additional trips to your job site. Check the dimensions and information below. Incorrect, missing or illegible dimensions may delay production and delivery.

LINERS

- ✓ **Vinyl Over Steps**
 - Fastener Type: Bead, Velcro, Rod Pockets, None.
 - Coping: Front or Top Mount.
 - Corners: Square, Diagonal or Radius.
 - Location: Indicate step's location.
- ✓ **A/B Points & Distances**
 - A/B Points – Indicate distance between A/B Points.
 - Sketch – Pool Shape, A/B line, hopper & pool direction.
- ✓ **Overall Dimensions**

New Pools – Provide manufacturer's panel layout, or see existing pools below.

Existing Pools – Please complete the Latham Order Form. Individual pool bottom measurements MUST = overall length and width (A&B) measurements.
- ✓ **Grecian Pools**

Provide dimensions for all sides of the pool & hopper pad shape. Measure to the point of the pool corner, not a radius coping.
- ✓ **Pool Corners**

Indicate Square, Diagonal or Radius. Indicate dimensions in inches. Guides are available to help determine sizes.
- ✓ **Color / Pattern / Thickness**

Clearly indicate these three choices.
- ✓ **ABG Liners**

Indicate: A) Wall height, B) Bead or Overlap, C) Make if non-standard.
- ✓ **Preformed Steps**

Indicate step location within pool perimeter for liner wall seam location.

SAFETY COVERS

- ✓ **Step Dimensions**

Double check Depth, Width, & Shape.
- ✓ **A/B Points & Distances**

Free Form Covers – include:

 - Distance between A/B points.
 - Pool sketch showing A/B line, pool direction, and all obstructions.
 - Replacement covers – measure to anchors and pool from the same A/B line.
- ✓ **Corners**

Indicate pool corners as Square, Diagonal or Radius. Include dimensions in inches. Guides are available to help determine sizes.
- ✓ **Grid Spacing**

Geometric shapes must indicate 3x3 or 5x5.
- ✓ **Grecian Covers**

Provide dimensions for all sides of the pool. Measure to the point of the pool corner, not a radius coping.
- ✓ **Color / Material**

Clearly indicate these choices.
- ✓ **Pump / Drain / Waiver**

One must be selected.
- ✓ **Deck Type & Size**
 - Confirm at least 3' of deck; decks less than 3' can use the reduced deck mount system.
 - Indicate Deck type, Anchor, and if padding is required.
- ✓ **Obstructions**
 - Indicate all non-removable obstructions within 3' of the pool.
 - Provide photos of all obstructions.